

60A,700V Insulated Gate Bipolar Transistor

Features

- Trench FS technology offering
- High speed switching
- Low gate charge and VCE(sat)
- High ruggedness, temperature stable behavior
- Maximum junction temperature 175°C

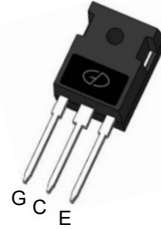

TO-247

Applications

- Solar Inverters
- Uninterruptible power supplies
- Motor drives
- Air condition

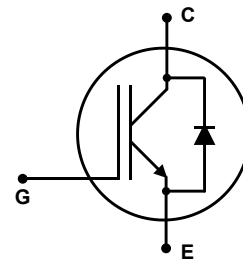

Absolute Maximum Ratings (@T_J=25°C unless otherwise noted)

Parameter	Symbol	Ratings	Unit
Collector-Emitter Voltage	V _{CES}	700	V
Gate- Emitter Voltage	V _{GES}	±30	V
Collector Current	I _C	120	A
Collector Current @TC = 100 °C		60	
Pulsed Collector Current, tp limited by Tjmax	I _{Cpuls}	240	A
Diode Continuous Forward Current @TC = 25 °C	I _F	120	A
Diode Continuous Forward Current @TC = 100 °C		60	
Power Dissipation @ TC = 25°C	P _D	319	W
Power Dissipation @ TC = 100°C		159	
Operating Junction	T _J	-55 to +175	°C
Storage Temperature Range	T _{STG}	-55 to +175	°C

Thermal Characteristics			
Parameter	Symbol	Max	Unit
Thermal Resistance ,Junction-to-Ambient	$R_{\theta JA}$	40	$^{\circ}C/W$
Thermal Resistance Junction-to-Case for IGBT	$R_{\theta JC}$	0.47	$^{\circ}C/W$
Thermal Resistance Junction-to-Case for Diode	$R_{\theta JC}$	0.98	$^{\circ}C/W$

Electrical Characteristics (@T _J =25°C unless otherwise noted)						
Parameter	Symbol	Test Conditions	Min	Typ	Max	Unit
Collector-Emitter Breakdown Voltage	V _{(BR)CES}	V _{GE} =0V, I _{CE} =1mA	700	--	--	V
Collector-Emitter Saturation Voltage	V _{CE(sat)}	I _C =60A, V _{GE} =15V	--	1.9	2.2	V
Gate Threshold Voltage	V _{GE(th)}	I _C =250μA, V _{CE} =V _{GE}	4	--	6	V
Collector-Emitter Leakage Current	I _{CES}	V _{GE} =0V, V _{CE} =700V	--	--	1	μA
Gate to Emitter Reverse Leakage	I _{GES}	V _{GE} =25V, V _{CE} =0V	--	--	100	nA
		V _{GE} =-25V, V _{CE} =0V	--	--	-100	
Input capacitance	C _{ies}	V _{GS} = 0V, V _{DS} = 25V f = 1MHz	--	2765	--	pF
Output capacitance	C _{oes}		--	125	--	
Reverse transfer capacitance	C _{res}		--	75	--	
Turn-on delay time	t _{d(on)}		--	31	--	
Rise time	t _r	V _{CC} =400V, I _C =60A, V _{GE} =0/15V, R _g =10Ω	--	62	--	ns
Turn-Off delay time	t _{d(off)}		--	148	--	
Fall time	t _f		--	57	--	
Turn-On Switching Loss	E _{on}		--	1.45	--	
Turn-Off Switching Loss	E _{off}	mJ	--	0.97	--	
Total Switching Loss	E _{ts}		--	2.42	--	
Total Gate Charge	Q _g	V _{CC} =480V, I _C =60A, V _{GE} =15V	--	158	--	nC
Gate to Emitter Charge	Q _{ge}		--	37	--	
Gate to Collector Charge	Q _{gc}		--	66	--	
Short circuit collector current Max.1000 short circuits Time between short circuits: ≥1.0s	I _{C(SC)}	V _{GE} =15V, V _{CC} ≤400V, t _{sc} ≤5μs	--	340	--	A

Electrical Characteristics of the Diode (@T _J =25°C unless otherwise noted)						
Parameter	Symbol	Test Conditions	Min	Typ	Max	Unit
Diode Forward Voltage	V _{FM}	I _F =60A	--	1.85	2.5	V
Reverse Recovery Time	t _{rr}	I _F =60A, I _F =60A, di/dt = 200A/μs	--	91	--	ns
Reverse Recovery Charge	Q _{rr}		--	0.8	--	μC
Diode Peak Reverse Recovery Current	I _{RRM}		--	17.6	--	A

Ratings and Characteristics Curves

($T_A = 25^\circ\text{C}$ unless otherwise noted)

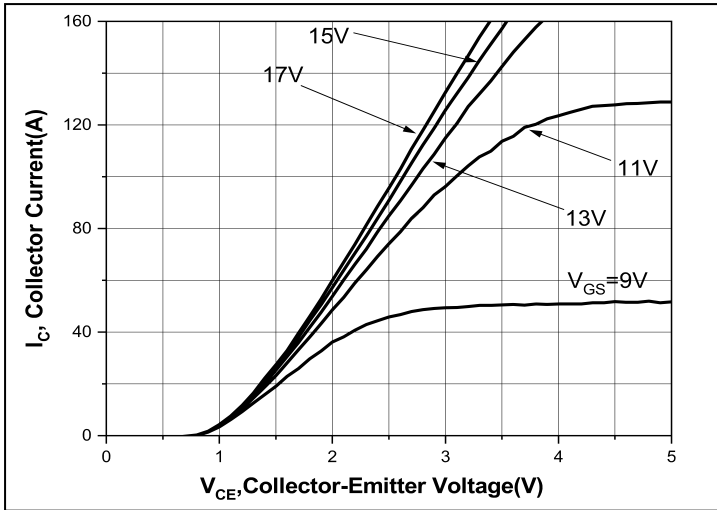

Figure1. Typical Output Characteristics

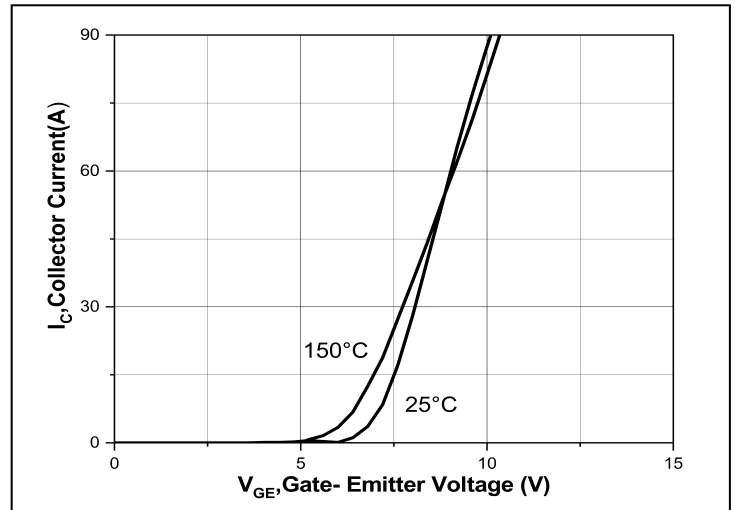

Figure2. Typical Transfer Characteristics

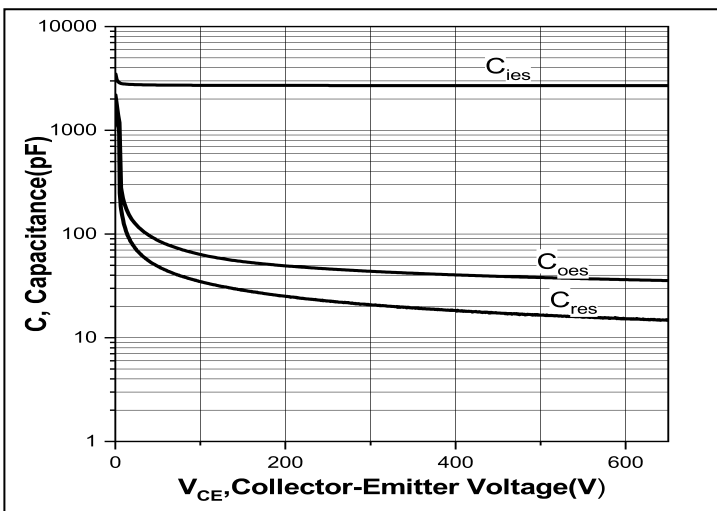

Figure3. Typical Capacitance

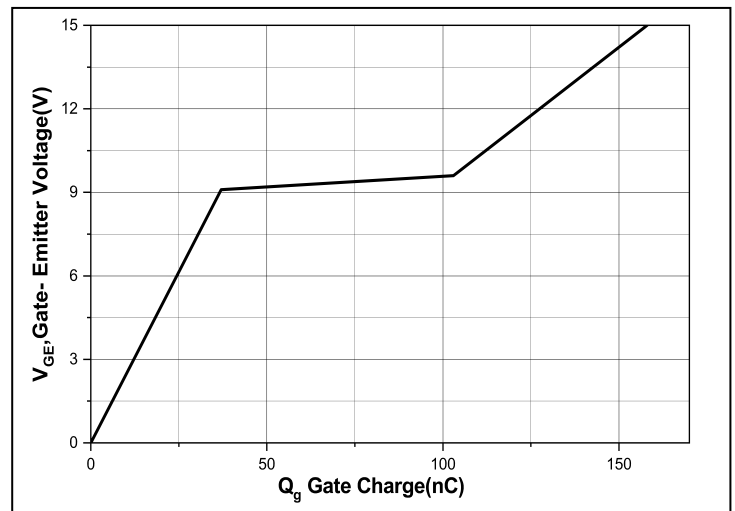

Figure4. Typical Gate Charge

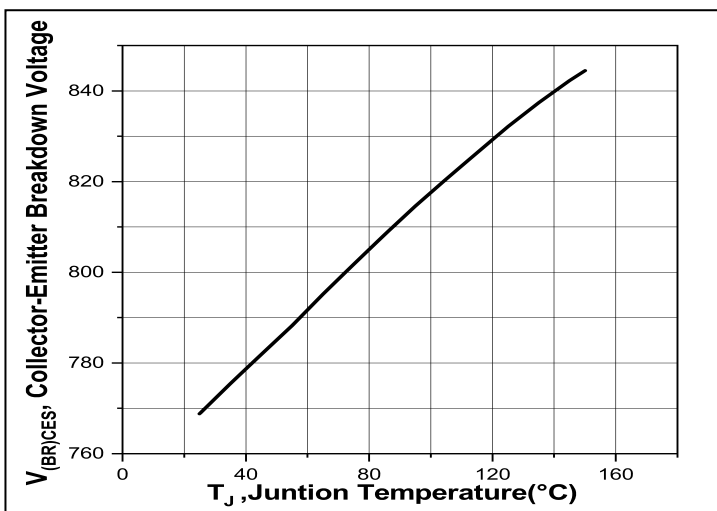

Figure5. Collector-Emmitter Breakdown Voltage vs. Temperature

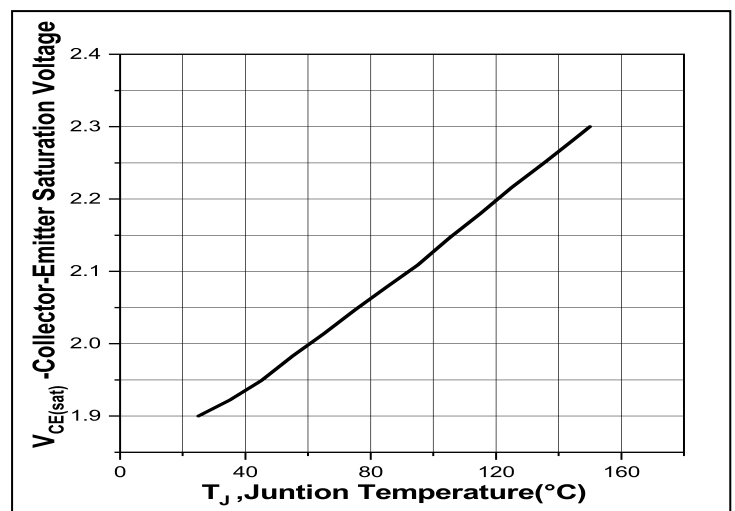

Figure6. Collector-Emmitter Saturation Voltage vs. Temperature

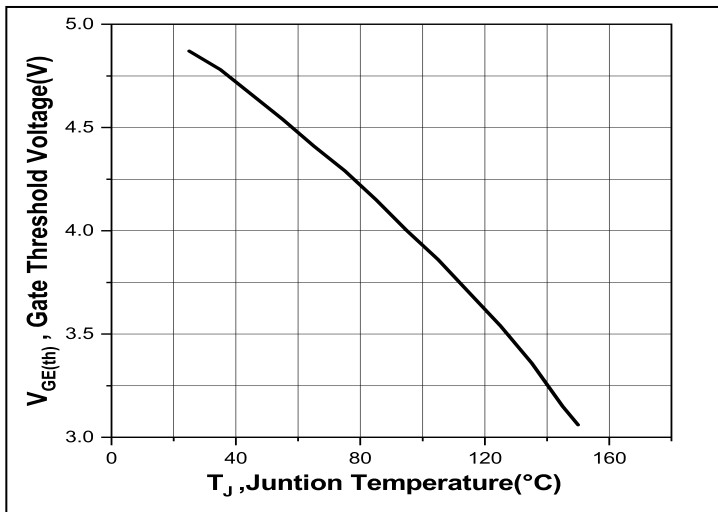

Figure7. Gate Threshold Voltage vs. Temperature

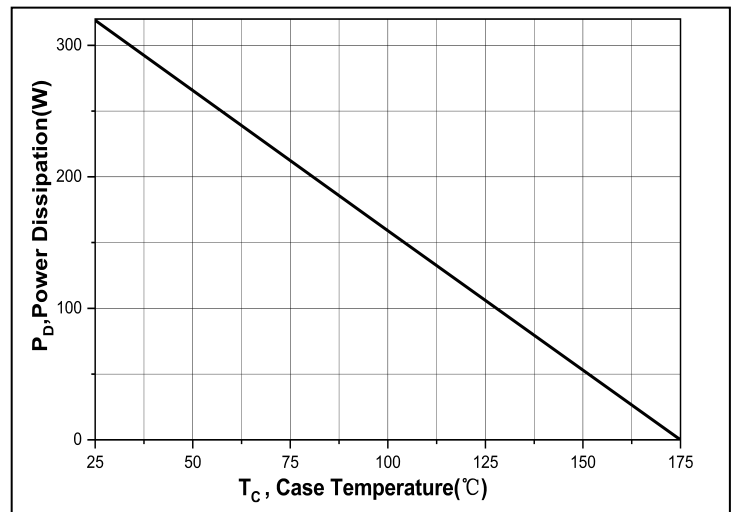

Figure8. Power Dissipation vs. Case Temperature

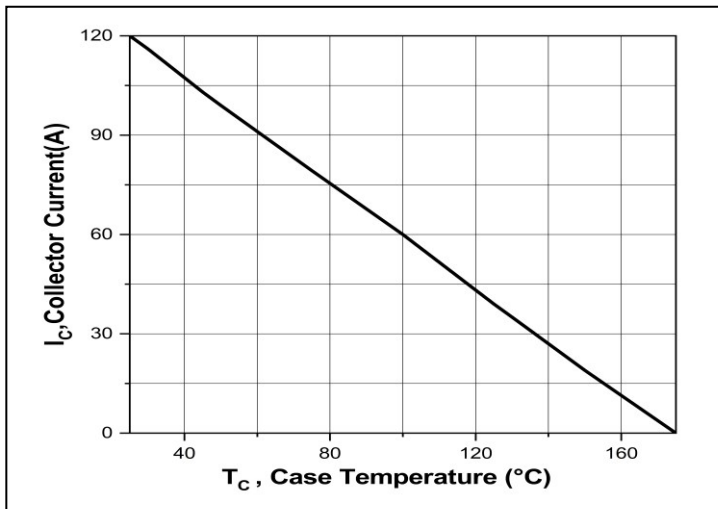
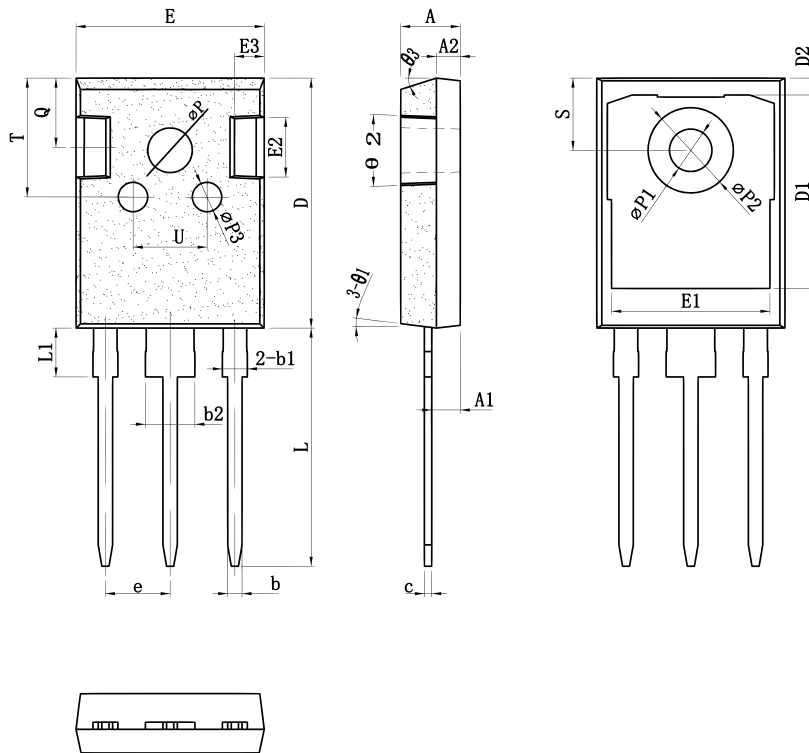

Figure9. Collector Current vs. Temperature

Package Outline Dimensions (Unit: millimeters)

TO-247

Option B:



SYMBOL	mm		
	MIN	NOM	MAX
*A	4.90	5.00	5.10
*A1	2.31	2.41	2.51
A2	1.90	2.00	2.10
*b	1.15	1.20	1.25
*b1	1.95	2.10	2.25
*b2	2.95	3.10	3.25
*c	0.55	0.60	0.65
*D	20.90	21.00	21.10
D1	16.35	16.55	16.75
D2	1.05	1.20	1.35
*E	15.70	15.80	15.90
E1	13.10	13.25	13.40
E2	4.90	5.00	5.10
E3	2.40	2.50	2.60
*e	5.40	5.44	5.48
*L	19.80	19.98	20.15
*L1	-	-	4.30
* ΦP	3.60	3.70	3.80
* $\Phi P1$	3.45	3.55	3.65
$\Phi P2$	7.03	7.18	7.33
$\Phi P3$	2.40	2.50	2.60
Q	5.60	5.80	6.00
*S	6.05	6.15	6.25
T	9.80	10.00	10.20
U	6.00	6.20	6.40
$\theta 1$	5°	7°	9°
$\theta 2$	1°	3°	5°
$\theta 3$	13°	15°	17°

Option H:

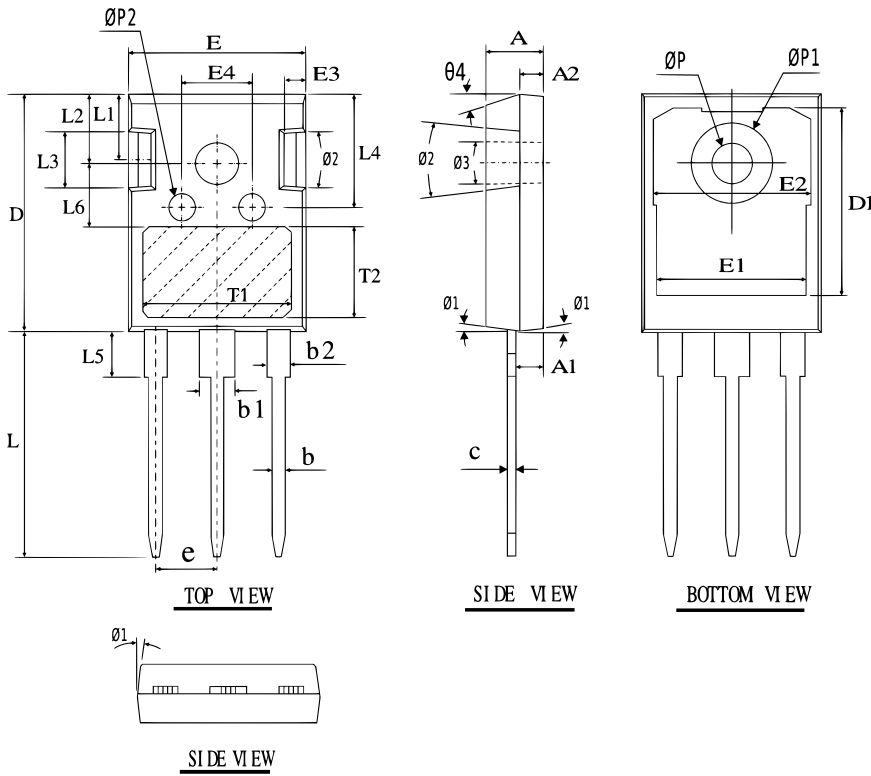

SYMBOL	MN	NOM	MAX
A	4.80	5.00	5.20
A1	2.20	2.40	2.60
A2	1.85	2.00	2.15
b	1.10	1.20	1.30
b1	2.80	3.00	3.20
b2	1.80	2.00	2.20
C	0.52	0.62	0.72
D	20.35	20.65	20.95
D1	16.35	16.55	16.75
E	15.50	15.80	16.10
E1	13.10	13.30	13.50
E2	13.80	14.00	14.20
E3	1.45	1.60	1.75
E4	6.00	6.20	6.40
L	19.80	20.00	20.20
L1	5.88	5.98	6.08
L2	5.88	5.98	6.08
L3	4.90	5.00	5.10
L4	9.70	9.80	9.90
L5	4.10	4.30	4.50
$\theta 1$	4°	7°	10°
$\theta 2$	11°	14°	17°
$\theta 3$	1°	--	2°
$\theta 4$	10°	15°	20°
$\varnothing P$	3.35	3.60	3.85
$\varnothing P1$	--	--	7.30
$\varnothing P2$	2.25	2.50	2.75
e		5.44BSC	
T1		12.80REF	
T2		7.80REF	
L6		5.50REF	

Marking Outline

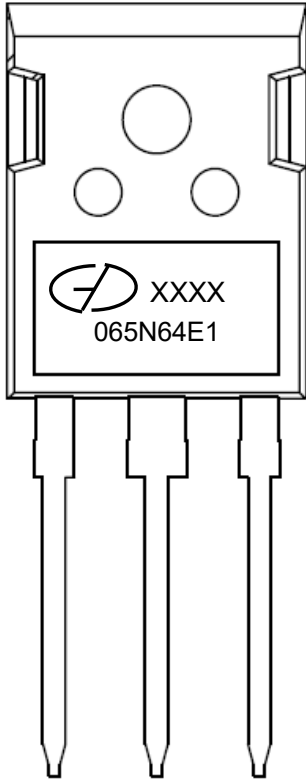

Part Name: GIT065N64E1

1. Logo Mark: 
2. P/N Mark: 065N64E1
3. Date Code: XXXX

Revision History

Version	Date	Major Changes
Rev.A	2025.02.07	Official Release

Disclaimers

These materials are intended as a reference to assist our customers in the selection of the Suzhou Good-Ark product best suited to the customer's application; they do not convey any license under any intellectual property rights, or any other rights, belonging to Suzhou Good-Ark Electronics Co., Ltd. or a third party.

Suzhou Good-Ark Electronics Co., Ltd. assumes no responsibility for any damage, or infringement of any third-party's rights, originating in the use of any product data, diagrams, charts, programs, algorithms, or circuit application examples contained in these materials.

All information contained in these materials, including product data, diagrams, charts, programs and algorithms represents information on products at the time of publication of these materials, and are subject to change by Suzhou Good-Ark Electronics Co., Ltd. without notice due to product improvements or other reasons. It is therefore recommended that customers contact Suzhou Good-Ark Electronics Co., Ltd. or an authorized Suzhou Good-Ark Electronics Co., Ltd. for the latest product information before purchasing a product listed herein. The information described here may contain technical inaccuracies or typographical errors. Suzhou Good-Ark Electronics Co., Ltd. assumes no responsibility for any damage, liability, or other loss rising from these inaccuracies or errors. Please also pay attention to information published by Suzhou Good-Ark Electronics Co., Ltd. by various means, including our website home page.

(<http://www.goodark.com>)

When using any or all of the information contained in these materials, including product data, diagrams, charts, programs, and algorithms, Please be sure to evaluate all information as a total system before making a final decision on the applicability of the information and products. Suzhou Good-Ark Electronics Co., Ltd. assumes no responsibility for any damage, liability or other loss resulting from the information contained herein.

The prior written approval of Suzhou Good-Ark Electronics Co., Ltd. is necessary to reprint or reproduce in whole or in part these materials.

Please contact Suzhou Good-Ark Electronics Co., Ltd. or an authorized distributor for further details on these materials or the products contained herein.