

## N-Channel 150V (D-S) Power MOSFET

### Features

- 100% Avalanche Tested
- Extremely Low Losses with Low FOM  $R_{ds(on)} \cdot Q_g$
- Halogen Free, Pb-Free
- RoHS Compliant

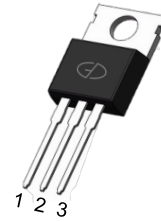

TO-220AB

### Applications

- DC/DC
- Motors, lamps
- Power switching

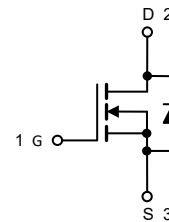

### Absolute Maximum Ratings ( $T_J=25^\circ\text{C}$ unless otherwise noted)

Parameter	Symbol	Value	Unit
Drain Source Voltage	$V_{DS}$	150	V
Gate Source Voltage	$V_{GS}$	$\pm 20$	V
Drain Current, Continuous $V_{GS}=10\text{V}$	$I_D$	$T_C=25^\circ\text{C}$	115
		$T_C=100^\circ\text{C}$	73
Drain Current, Pulsed (Note 1)	$I_{DM}$	460	A
Single Avalanche Energy (Note 2)	$E_{AS}$	440	mJ
Power Dissipation	$P_D$	$T_C=25^\circ\text{C}$	313
		$T_C=100^\circ\text{C}$	125
Operating Junction/ Storage Temperature Range	$T_J / T_{STG}$	-55 to +150	$^\circ\text{C}$

Note 1: Single pulse;  $t_p \leq 1\mu\text{s}$ .

Note 2:  $V_{DD} = 20\text{V}$ ,  $V_{GS} = 10\text{V}$ ,  $L = 0.5\text{mH}$ ,  $R_G = 25\Omega$ , starting  $T_J = 25^\circ\text{C}$ .

### Thermal Characteristics

Parameter	Symbol	Max	Unit
Thermal Resistance Junction to Case	$R_{thJC}$	0.4	$^\circ\text{C/W}$
Thermal Resistance Junction to Ambient (Note 3)	$R_{thJA}$	62.5	$^\circ\text{C/W}$

Note 3: Device mounted on 1 square inch FR4 PCB board, with 2oz single-sided copper, in a  $25^\circ\text{C}$  still air environment.

### Electrical Characteristics (T<sub>J</sub> =25°C unless otherwise noted)

Parameter	Symbol	Test Conditions	Min	Typ	Max	Unit
Drain Source Breakdown Voltage	V <sub>(BR)DSS</sub>	V <sub>GS</sub> =0V, I <sub>D</sub> =250μA	150	--	--	V
Zero Gate Voltage Drain Current	I <sub>DSS</sub>	V <sub>DS</sub> =150V, V <sub>GS</sub> =0V	--	--	1	uA
Gate Threshold Voltage	V <sub>GS(TH)</sub>	V <sub>DS</sub> =V <sub>GS</sub> , I <sub>DS</sub> =250uA	2	--	4	V
Gate Leakage Current	I <sub>GSS</sub>	V <sub>GS</sub> =±20V, V <sub>DS</sub> =0V	--	--	±100	nA
Drain-Source On-state Resistance (Note 4)	R <sub>DS(on)</sub>	V <sub>GS</sub> =10V, I <sub>D</sub> =20A	--	9.3	10.5	mΩ
Total Gate Charge	Q <sub>g</sub>	V <sub>GS(off)</sub> =0V, V <sub>GS(on)</sub> =10V, V <sub>DD</sub> =75V, I <sub>D</sub> =30A	--	53.1	--	nC
Gate-Source Charge	Q <sub>gs</sub>		--	14.5	--	
Gate-Drain Charge	Q <sub>gd</sub>		--	7	--	
Turn-on Delay Time	t <sub>d(on)</sub>	V <sub>GS</sub> =10V, V <sub>DD</sub> =75V, I <sub>D</sub> =30A, R <sub>G</sub> =3.3Ω	--	21	--	ns
Turn-on Rise Time	t <sub>r</sub>		--	14	--	
Turn-off Delay Time	t <sub>d(off)</sub>		--	41	--	
Turn-off Fall Time	t <sub>f</sub>		--	13	--	
Gate Resistance	R <sub>g</sub>	V <sub>GS</sub> =0V, f=1MHz, open drain	--	1.7	--	Ω
Input Capacitance	C <sub>iss</sub>	V <sub>GS</sub> =0V, V <sub>DS</sub> =75V, f=250kHz	--	4004	--	pF
Output Capacitance	C <sub>oss</sub>		--	272	--	
Reverse Transfer Capacitance	C <sub>rss</sub>		--	8.8	--	

### Reverse Diode Characteristics (T<sub>J</sub> =25°C unless otherwise noted)

Parameter	Symbol	Test Conditions	Min	Typ	Max	Unit
Forward Current, Continuous	I <sub>SD</sub>	T <sub>C</sub> =25°C	--	--	130	A
Diode Forward Voltage (Note 4)	V <sub>SD</sub>	I <sub>F</sub> =20A, V <sub>GS</sub> =0V	--	--	1.2	V
Reverse Recovery Time	T <sub>rr</sub>	V <sub>R</sub> =75V, I <sub>F</sub> =20A, di/dt=100A/μs	--	66	--	ns
Reverse Recovery Charge	Q <sub>rr</sub>		--	210	--	nC

Note 4: Pulse test; pulse width ≤ 380μs, duty cycle ≤ 1%.

## Typical Characteristics Curves ( $T_J = 25^\circ\text{C}$ unless otherwise noted)

Fig.1 - Output Characteristics

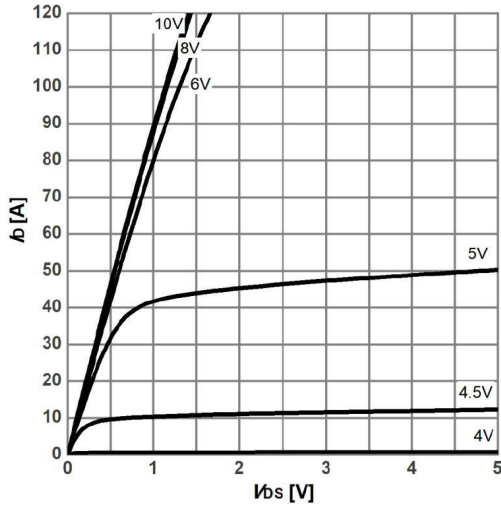

Fig.2 - Transfer Characteristics

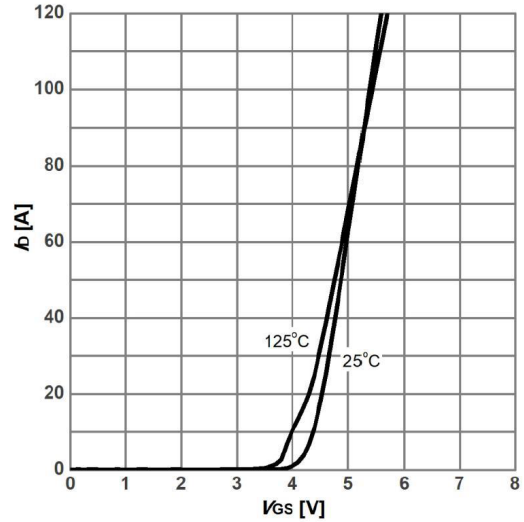

Fig.3 - Drain-Source On-Resistance

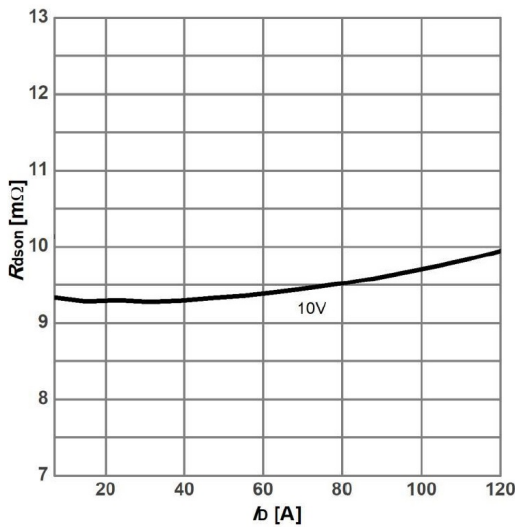

Fig.4 - Drain-Source On-Resistance

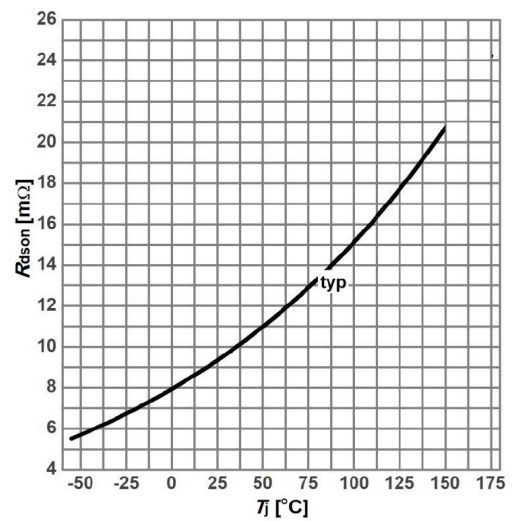

Fig.5 - Drain-Source On-Resistance

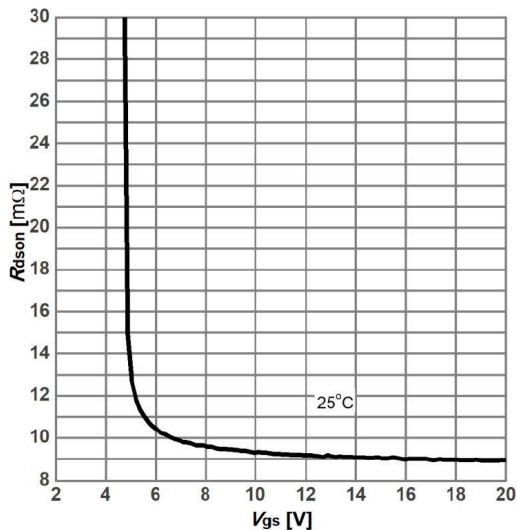
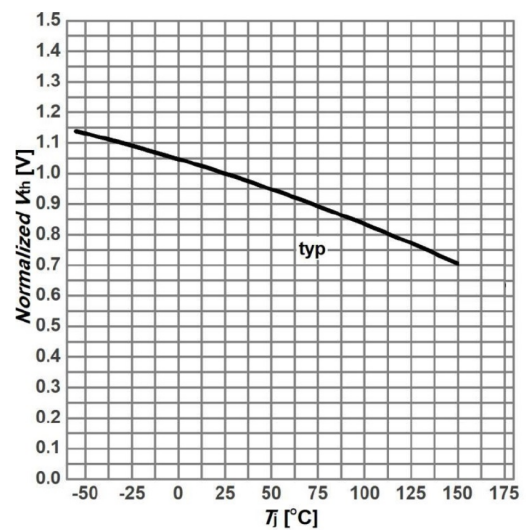

Fig.6 - Normalized Threshold Voltage



## Typical Characteristics Curves ( $T_J = 25^\circ\text{C}$ unless otherwise noted)

Fig.7 - Capacitance

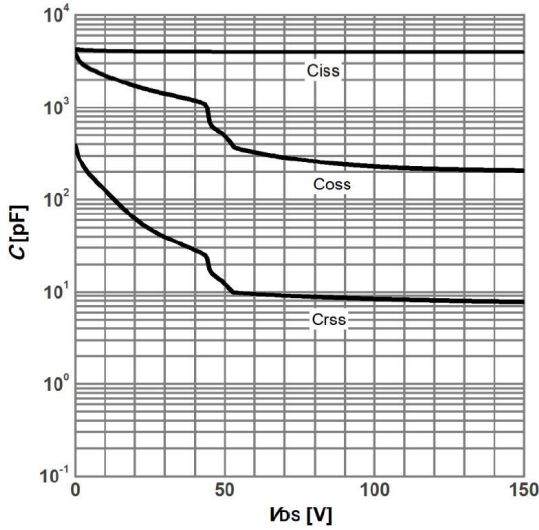

Fig.8 - Gate charge

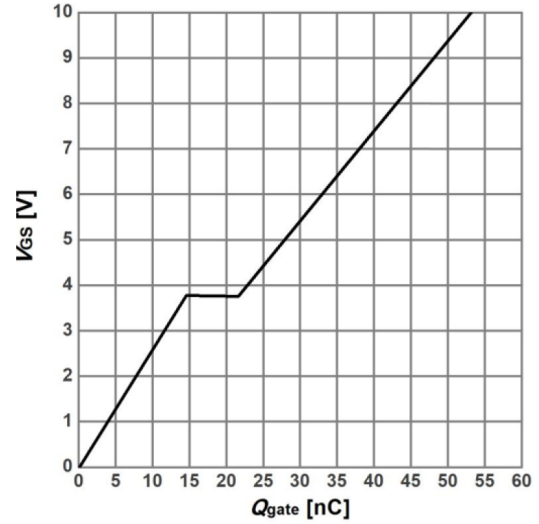

Fig.9 - Forward Characteristic

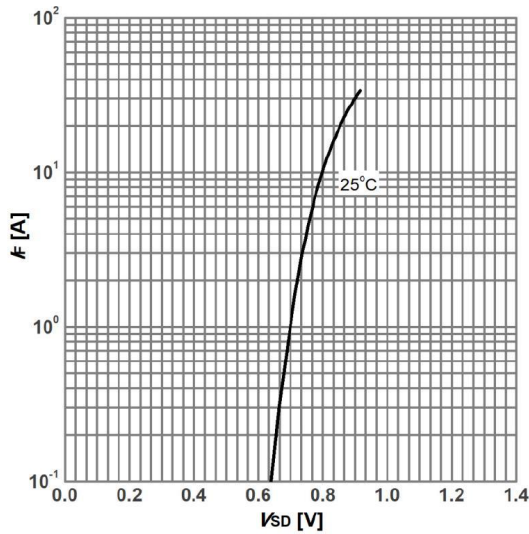

Fig.10 - Safe Operating Area

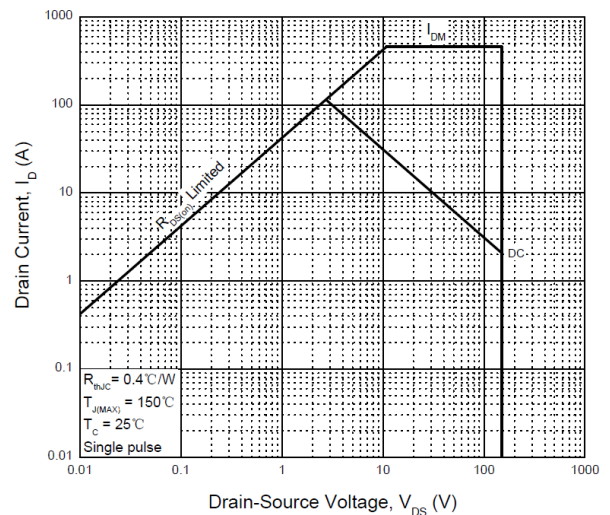

Fig.11 - Thermal Impedance, Junction-Case

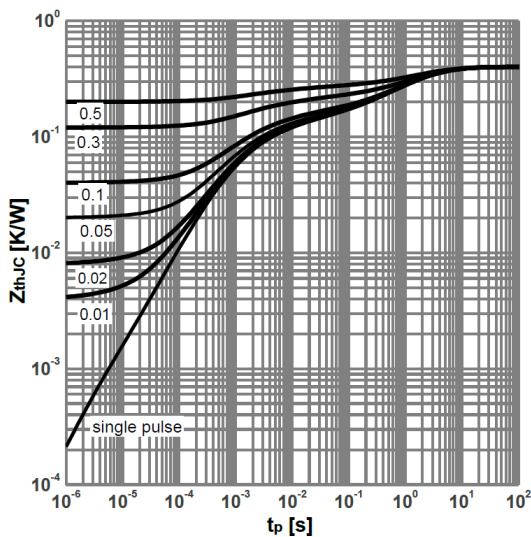
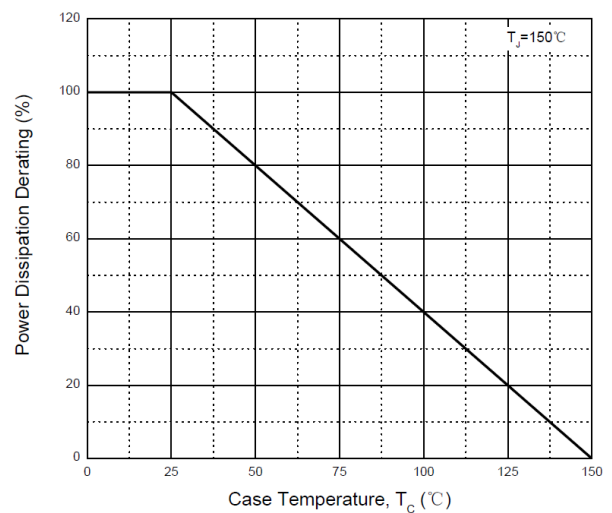
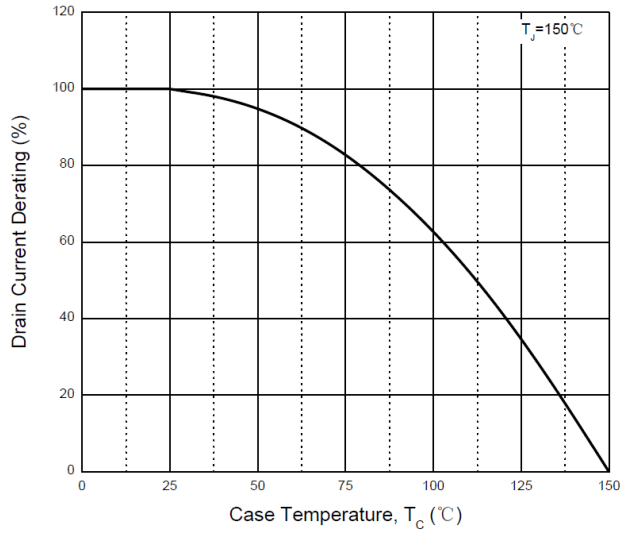

Fig.12 - Power Derating



**Typical Characteristics Curves** ( $T_J = 25^\circ\text{C}$  unless otherwise noted)

Fig.13 - Drain Current Derating



**Package Outline Dimensions** (Unit: millimeters)

**TO-220AB**

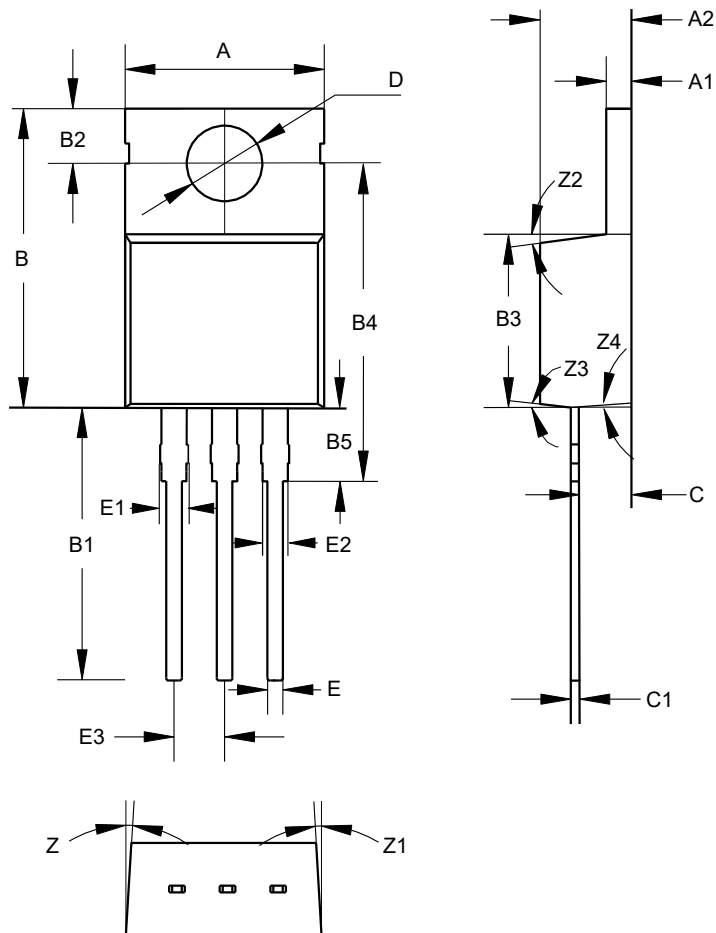

TO-220AB							
	Min.	Nom.	Max.		Min.	Nom.	Max.
A	9.8	10	10.2	D	3.7	3.8	3.9
A1	1.17	1.27	1.37	E	0.68	0.78	0.88
A2	4.5	4.6	4.7	E1	1.2	1.4	1.6
B	14.5	15	15.5	E2	1.17	1.27	1.37
B1	13.2	13.7	14.2	E3	2.44	2.54	2.64
B2	2.65	2.75	2.85	Z	-	3°	-
B3	8.5	8.7	8.9	Z1	-	3°	-
B4	15.5	16	16.5	Z2	-	7°	-
B5	3.4	3.7	4.0	Z3	-	7°	-
C	2.3	2.6	2.9	Z4	-	1.5°	-
C1	0.28	0.38	0.48	-	-	-	-

## Marking Outline

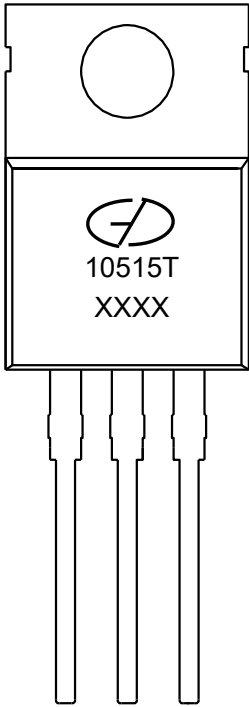

Part Name: GMN10515T

1. Logo Mark: 
2. P/N Mark: 10515T
3. Date Code: XXXX

## Revision History

Version	Date	Major Changes
Rev.A	2024.07.11	Official Release

## Disclaimers

These materials are intended as a reference to assist our customers in the selection of the Suzhou Good-Ark product best suited to the customer's application; they do not convey any license under any intellectual property rights, or any other rights, belonging to Suzhou Good-Ark Electronics Co., Ltd. or a third party.

Suzhou Good-Ark Electronics Co., Ltd. assumes no responsibility for any damage, or infringement of any third-party's rights, originating in the use of any product data, diagrams, charts, programs, algorithms, or circuit application examples contained in these materials.

All information contained in these materials, including product data, diagrams, charts, programs and algorithms represents information on products at the time of publication of these materials, and are subject to change by Suzhou Good-Ark Electronics Co., Ltd. without notice due to product improvements or other reasons. It is therefore recommended that customers contact Suzhou Good-Ark Electronics Co., Ltd. or an authorized Suzhou Good-Ark Electronics Co., Ltd. for the latest product information before purchasing a product listed herein. The information described here may contain technical inaccuracies or typographical errors. Suzhou Good-Ark Electronics Co., Ltd. assumes no responsibility for any damage, liability, or other loss rising from these inaccuracies or errors. Please also pay attention to information published by Suzhou Good-Ark Electronics Co., Ltd. by various means, including our website home page.

(<http://www.goodark.com>)

When using any or all of the information contained in these materials, including product data, diagrams, charts, programs, and algorithms, please be sure to evaluate all information as a total system before making a final decision on the applicability of the information and products. Suzhou Good-Ark Electronics Co., Ltd. assumes no responsibility for any damage, liability or other loss resulting from the information contained herein.

The prior written approval of Suzhou Good-Ark Electronics Co., Ltd. is necessary to reprint or reproduce in whole or in part these materials.

Please contact Suzhou Good-Ark Electronics Co., Ltd. or an authorized distributor for further details on these materials or the products contained herein.