

20A, 1200V Silicon Carbide Schottky Diode

Features

- High-Frequency Operation
- Zero Reverse Recovery Current
- Temperature-Independent Switching
- Extremely Fast Switching
- Plastic package has underwriters Laboratory Flammability Classification 94V-0
- Halogen-free according to IEC 61249-2-21

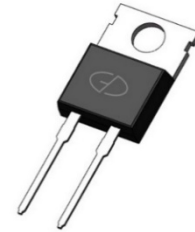

TO-220AC

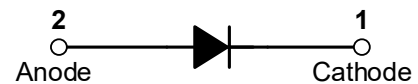

Applications

- Boost Diodes in PFC or DC/DC stages
- LED Lighting Power Supplies
- Power Factor Correction

Mechanical Data

- Case: Epoxy, Molded
- Finish: All External Surfaces Corrosion Resistant and Terminal Leads are Readily Solderable
- Lead Temperature for Soldering Purposes: 260°C Max. for 10 sec
- Shipped 50 units per plastic tube

Maximum Ratings & Electrical Characteristics ($T_A=25^{\circ}\text{C}$ unless otherwise noted)				
Parameter	Symbol	GS20D120ST	Unit	
Maximum repetitive peak reverse voltage	V_{RRM}	1200	V	
Working peak reverse voltage	V_{RWM}	1200	V	
Maximum DC blocking voltage	V_{DC}	1200	V	
Maximum average forward rectified current	$T_C=25^{\circ}\text{C}$	69	A	
	$T_C=135^{\circ}\text{C}$	32		
	$T_C=154^{\circ}\text{C}$	20		
Peak forward surge current, $t_p=10\text{ms}$, Half Sine Pulse	I_{FSM}	140	A	
Power dissipation	$T_C=25^{\circ}\text{C}$	333	W	
	$T_C=110^{\circ}\text{C}$	144		
Operating junction temperature range	T_J	-55 to +175	$^{\circ}\text{C}$	
Storage temperature range	T_{STG}	-55 to +175	$^{\circ}\text{C}$	

Electrical Specifications ($T_A=25^{\circ}\text{C}$ unless otherwise noted)					
Parameter	Symbol	Test Conditions	Typ	Max	Unit
Forward drop voltage	V_F	$I_F=20\text{A}, T_J=25^{\circ}\text{C}$	1.45	1.75	V
		$I_F=20\text{A}, T_J=175^{\circ}\text{C}$	2.20	2.60	
Reverse leakage current @rated V_R	I_R	$V_R=1200\text{V}, T_J=25^{\circ}\text{C}$	15	200	μA
		$V_R=1200\text{V}, T_J=175^{\circ}\text{C}$	50	500	
Total capacitive charge	Q_C	$V_R=800\text{V}, I_F=20\text{A}, T_J=25^{\circ}\text{C}$	126	-	nC
Total capacitance	C	$V_R=800\text{V}, T_J=25^{\circ}\text{C}, f=1\text{MHz}$	95	-	pF

Thermal-Mechanical Specifications ($T_A=25^{\circ}\text{C}$ unless otherwise noted)				
Parameter	Symbol	Typ	Max	Unit
Thermal Resistance, Junction to Case	$R_{\theta JC}$	0.45	-	$^{\circ}\text{C}/\text{W}$

Ratings and Characteristics Curves

($T_A = 25^\circ\text{C}$ unless otherwise noted)

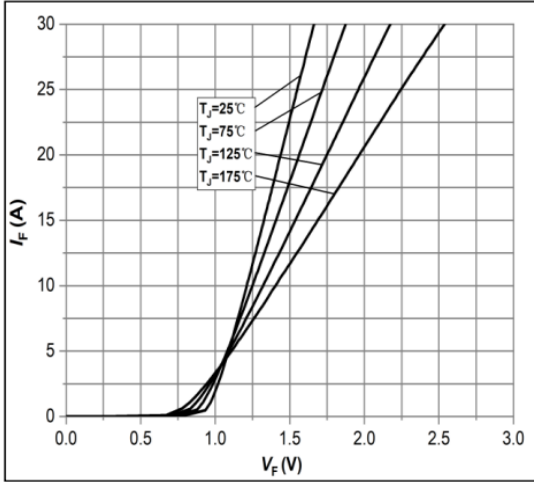

Fig.1 -Forward Characteristics

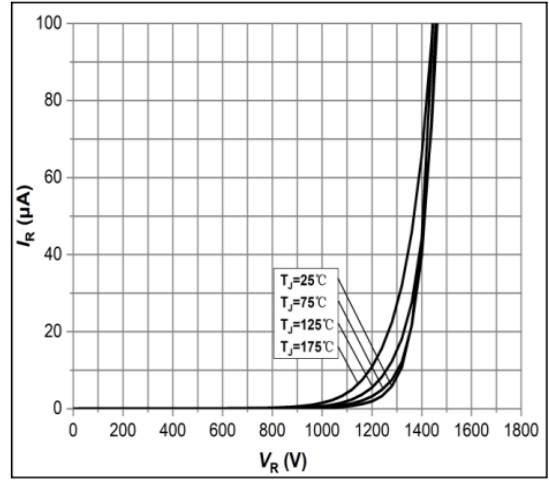

Fig.2 -Reverse Characteristics

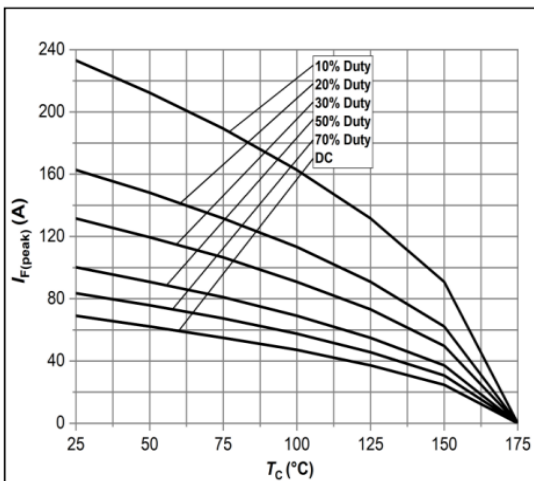

Fig.3 -Current Derating

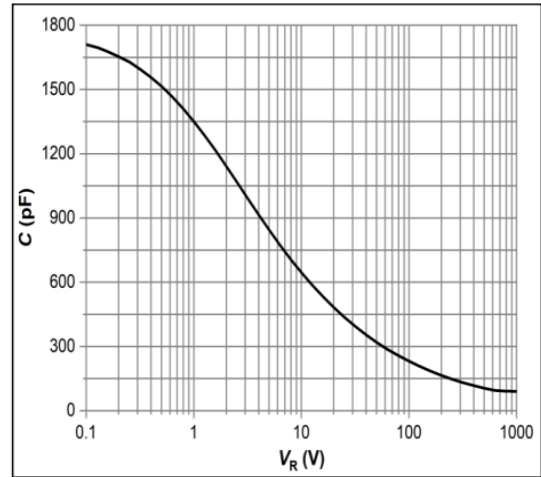

Fig.4 -Capacitance vs. Reverse Voltage

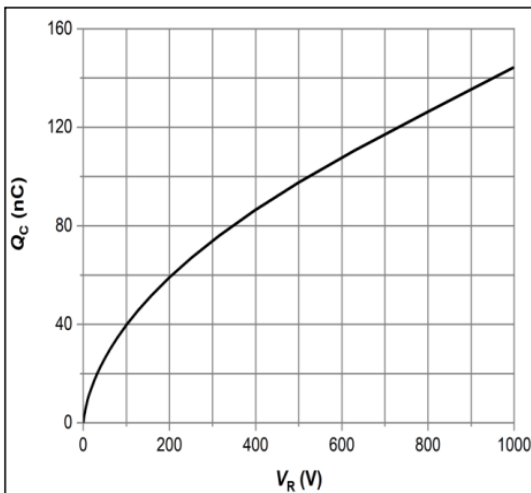

Fig.5 -Total Capacitance Charge vs. Reverse Voltage

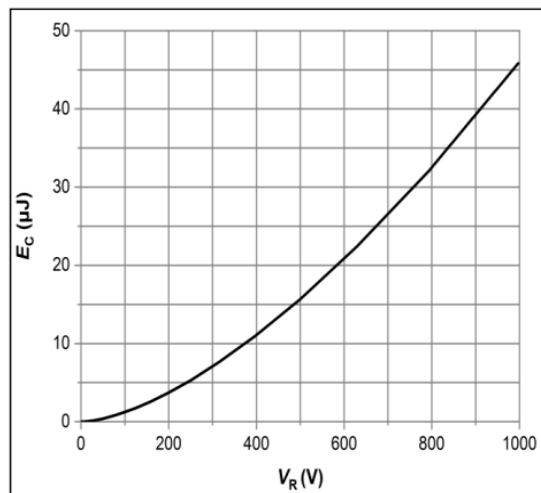
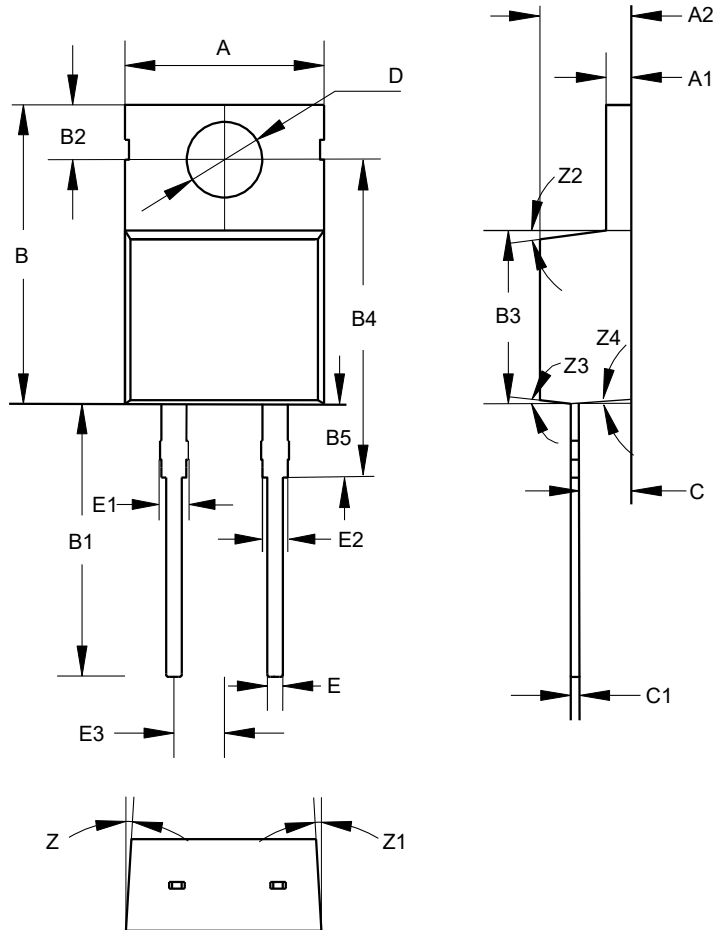

Fig.6 -Typical Capacitance Stored Energy

Package Outline Dimensions (Unit: millimeters)

TO-220AC



TO-220AC							
	Min.	Nom.	Max.		Min.	Nom.	Max.
A	9.8	10	10.2	D	3.7	3.8	3.9
A1	1.17	1.27	1.37	E	0.68	0.78	0.88
A2	4.5	4.6	4.7	E1	1.2	1.4	1.6
B	14.5	15	15.5	E2	1.17	1.27	1.37
B1	13.2	13.7	14.2	E3	2.44	2.54	2.64
B2	2.65	2.75	2.85	Z		3°	
B3	8.5	8.7	8.9	Z1		3°	
B4	15.5	16	16.5	Z2		7°	
B5	3.4	3.7	4.0	Z3		7°	
C	2.3	2.6	2.9	Z4		1.5°	
C1	0.28	0.38	0.48				

Marking Outline

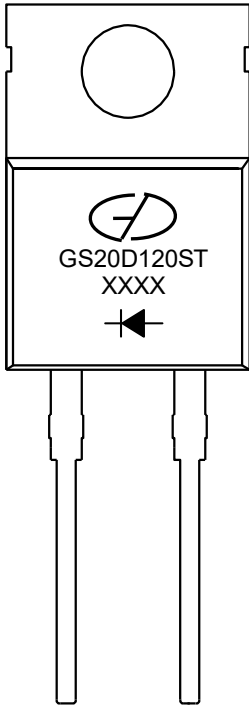

1. Logo Mark: 
2. Part Name: GS20D120ST
3. Date Code: XXXX
4. Polarity : 

Revision History

Document Version	Date of release	Description of changes
Rev.A	2022.06.22	Preliminary Datasheet

Disclaimers

These materials are intended as a reference to assist our customers in the selection of the Suzhou Good-Ark product best suited to the customer's application; they do not convey any license under any intellectual property rights, or any other rights, belonging to Suzhou Good-Ark Electronics Co., Ltd. or a third party.

Suzhou Good-Ark Electronics Co., Ltd. assumes no responsibility for any damage, or infringement of any third-party's rights, originating in the use of any product data, diagrams, charts, programs, algorithms, or circuit application examples contained in these materials.

All information contained in these materials, including product data, diagrams, charts, programs and algorithms represents information on products at the time of publication of these materials, and are subject to change by Suzhou Good-Ark Electronics Co., Ltd. without notice due to product improvements or other reasons. It is therefore recommended that customers contact Suzhou Good-Ark Electronics Co., Ltd. or an authorized Suzhou Good-Ark Electronics Co., Ltd. for the latest product information before purchasing a product listed herein. The information described here may contain technical inaccuracies or typographical errors. Suzhou Good-Ark Electronics Co., Ltd. assumes no responsibility for any damage, liability, or other loss rising from these inaccuracies or errors. Please also pay attention to information published by Suzhou Good-Ark Electronics Co., Ltd. by various means, including our website home page.

(<http://www.goodark.com>)

When using any or all of the information contained in these materials, including product data, diagrams, charts, programs, and algorithms, Please be sure to evaluate all information as a total system before making a final decision on the applicability of the information and products. Suzhou Good-Ark Electronics Co., Ltd. assumes no responsibility for any damage, liability or other loss resulting from the information contained herein.

The prior written approval of Suzhou Good-Ark Electronics Co., Ltd. is necessary to reprint or reproduce in whole or in part these materials.

Please contact Suzhou Good-Ark Electronics Co., Ltd. or an authorized distributor for further details on these materials or the products contained herein.