

N-Channel 60V (D-S) Power MOSFET

Features

- 100% Avalanche Tested
- Extremely Low Losses with Low FOM $R_{ds(on)} \cdot Q_g$
- Halogen Free, Pb-Free
- RoHS Compliant

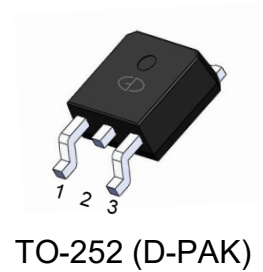

Applications

- DC/DC
- Motors, lamps
- Power switching

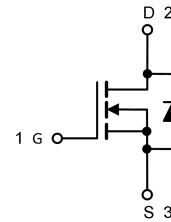

Absolute Maximum Ratings ($T_J=25^\circ\text{C}$ unless otherwise noted)

Parameter	Symbol	Value	Unit
Drain Source Voltage	V_{DS}	60	V
Gate Source Voltage	V_{GS}	± 20	V
Drain Current, Continuous $V_{GS}=10\text{V}$	I_D	80	A
$T_C=25^\circ\text{C}$			
Drain Current, Pulsed (Note 1)	I_{DM}	320	A
Single Avalanche Energy (Note 2)	E_{AS}	210	mJ
Power Dissipation	P_D	74	W
$T_C=25^\circ\text{C}$			
Operating Junction/ Storage Temperature Range	T_J / T_{STG}	-55 to +150	$^\circ\text{C}$

Note 1: Single pulse; $t_p \leq 1\mu\text{s}$.

Note 2: $V_{DD} = 20\text{V}$, $V_{GS} = 10\text{V}$, $L = 0.5\text{mH}$, $R_G = 25\Omega$, starting $T_J = 25^\circ\text{C}$.

Thermal Characteristics

Parameter	Symbol	Max	Unit
Thermal Resistance Junction to Case	R_{thJC}	1.7	$^\circ\text{C/W}$

Electrical Characteristics (T_J = 25°C unless otherwise noted)

Parameter	Symbol	Test Conditions	Min	Typ	Max	Unit
Drain Source Breakdown Voltage	V _{(BR)DSS}	V _{GS} =0V, I _D =250μA	60	--	--	V
Zero Gate Voltage Drain Current	I _{DSS}	V _{DS} =60V, V _{GS} =0V	--	--	1	uA
Gate Threshold Voltage	V _{GS(TH)}	V _{DS} =V _{GS} , I _{DS} =250uA	2	--	4	V
Gate Leakage Current	I _{GSS}	V _{GS} =±20V, V _{DS} =0V	--	--	±100	nA
Drain-Source On-state Resistance (Note 4)	R _{DS(on)}	V _{GS} =10V, I _D =20A	--	6.3	8	mΩ
Total Gate Charge	Q _g	V _{GS(off)} =0V, V _{GS(on)} =10V, V _{DD} =30V, I _D =20A	--	70	--	nC
Gate-Source Charge	Q _{gs}		--	15	--	
Gate-Drain Charge	Q _{gd}		--	22	--	
Turn-on Delay Time	t _{d(on)}	V _{GS} =10V, V _{DD} =30V, I _D =30A, R _G =3Ω	--	15	--	ns
Turn-on Rise Time	t _r		--	22	--	
Turn-off Delay Time	t _{d(off)}		--	40	--	
Turn-off Fall Time	t _f		--	8.6	--	
Input Capacitance	C _{iss}	V _{GS} =0V, V _{DS} =60V, f=1MHz	--	3450	--	pF
Output Capacitance	C _{oss}		--	180	--	
Reverse Transfer Capacitance	C _{rss}		--	165	--	

Reverse Diode Characteristics (T_J = 25°C unless otherwise noted)

Parameter	Symbol	Test Conditions	Min	Typ	Max	Unit
Forward Current, Continuous	I _{SD}	T _C =25°C	--	--	80	A
Diode Forward Voltage (Note 3)	V _{SD}	I _F =20A, V _{GS} =0V	--	--	1.2	V
Reverse Recovery Time	T _{rr}	I _F = 20A, di/dt = 100 A/μs	--	25	--	ns
Reverse Recovery Charge	Q _{rr}		--	30	--	nC

Note 3: Pulse test; pulse width ≤ 380μs, duty cycle ≤ 1%.

Typical Characteristics Curves ($T_J = 25^\circ\text{C}$ unless otherwise noted)

Fig.1 - Output Characteristics

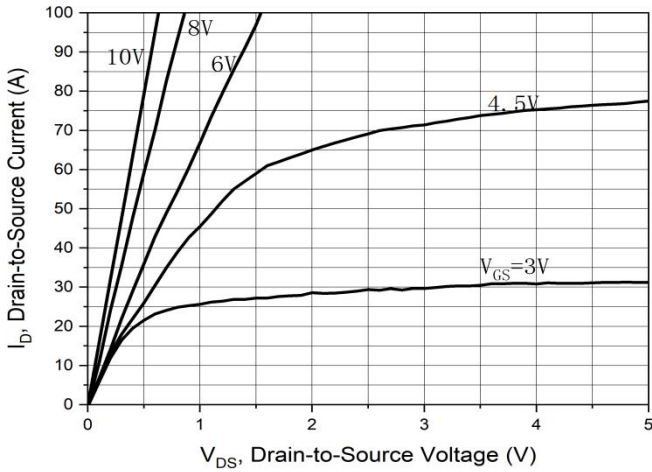

Fig.2 - Drain-to-Source Breakdown Voltage vs. Junction Temperature

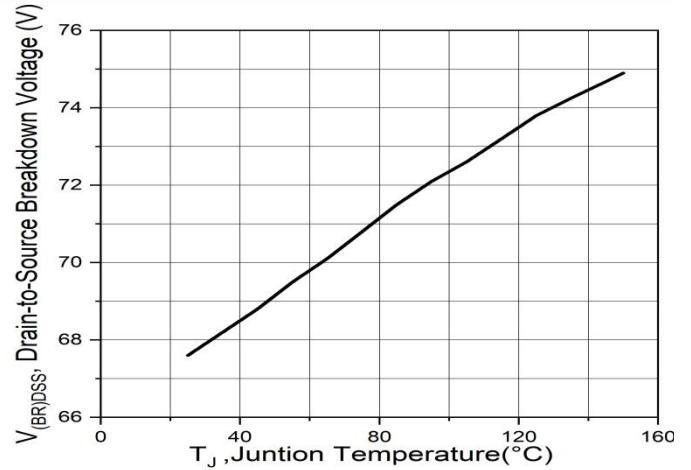

Fig.3 - RDS(on) vs. Junction Temperature

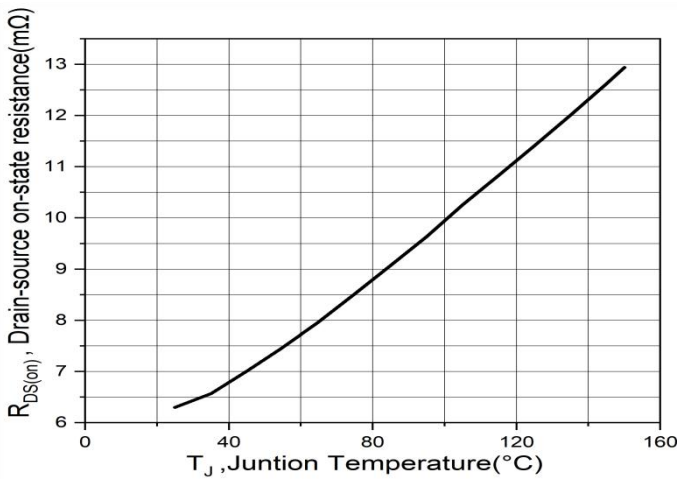

Fig.4 - V_{th} vs. Junction Temperature

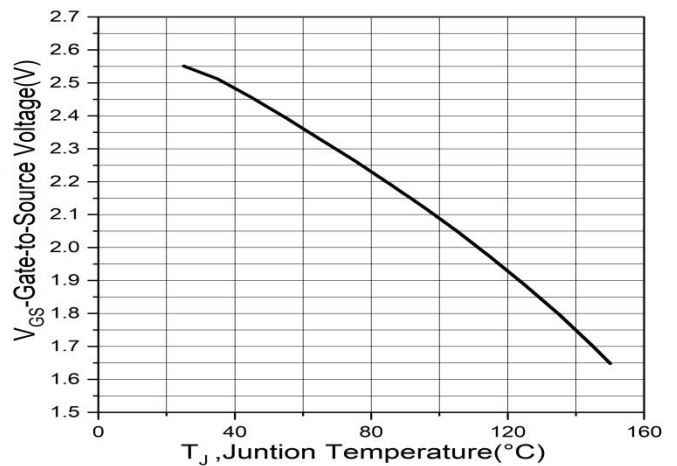

Fig.5 - Capacitance

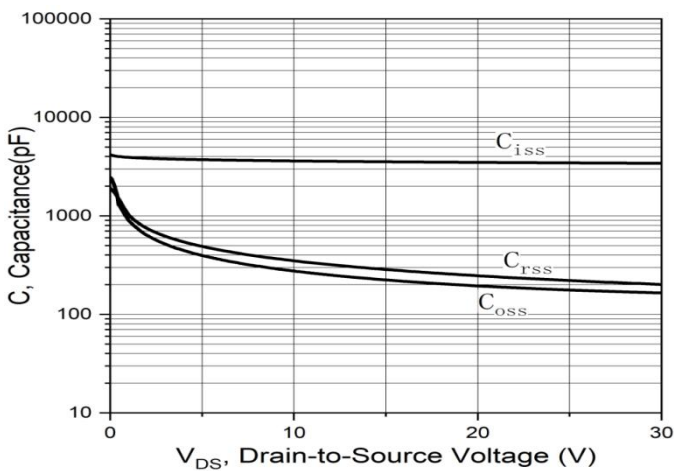
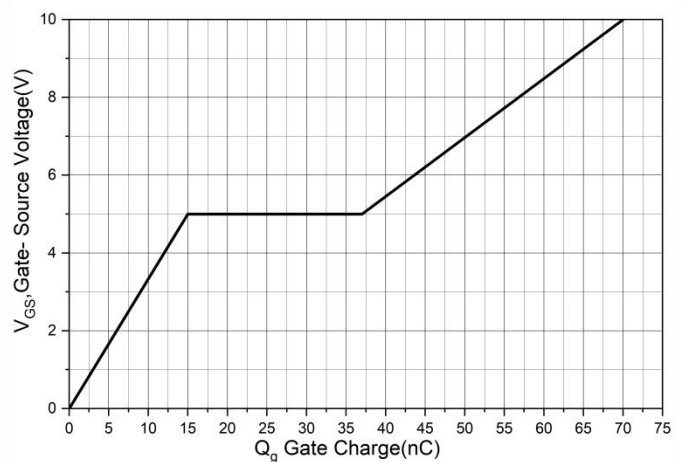

Fig.6 - Gate Charge



Typical Characteristics Curves ($T_J = 25^\circ\text{C}$ unless otherwise noted)

Fig.7 - Transfer Characteristics

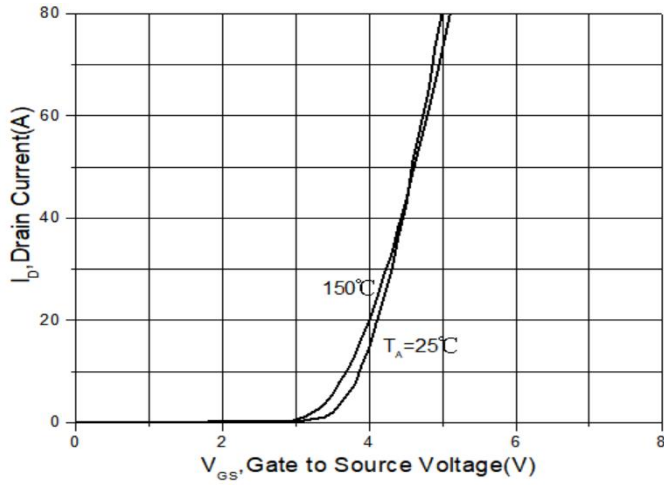
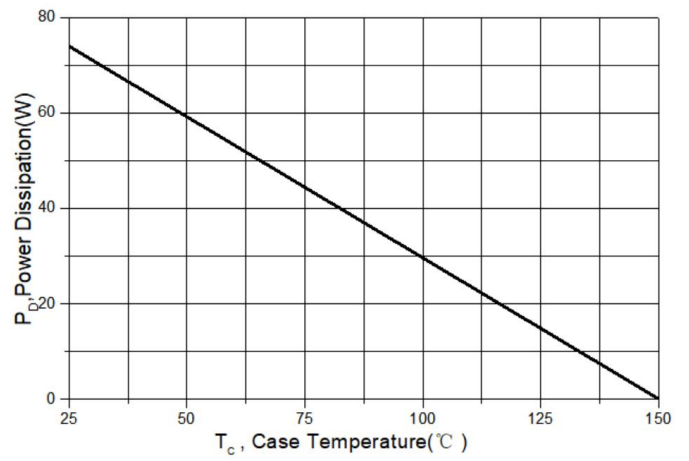
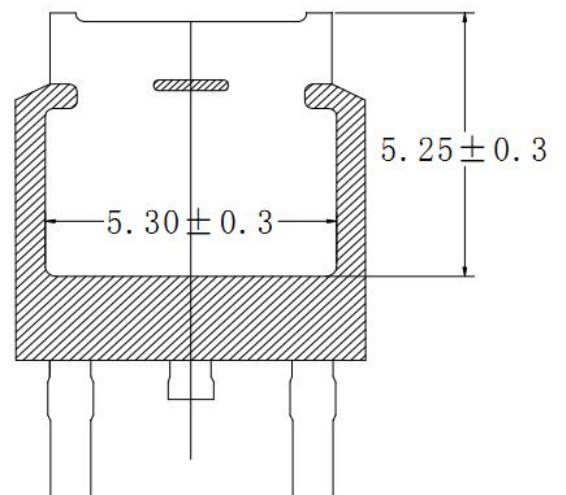
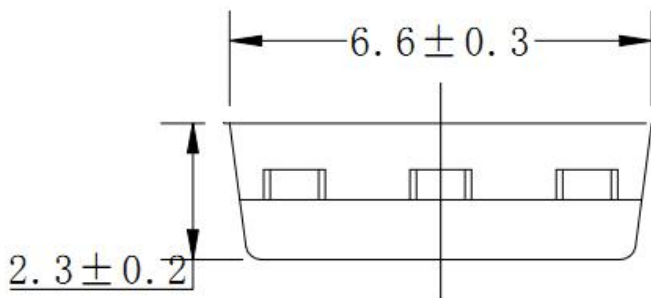
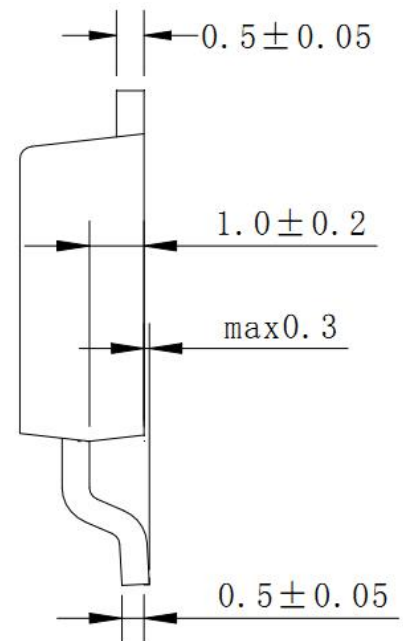
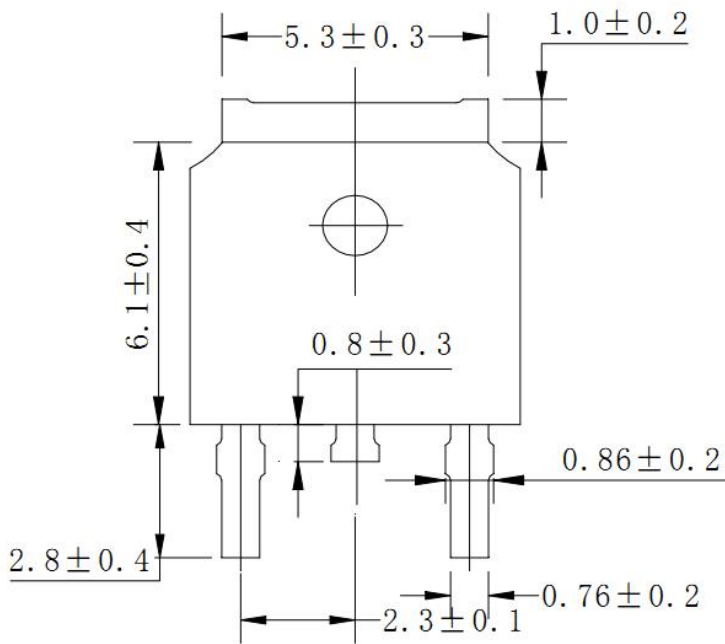

Fig.8 - Power Dissipation



Package Outline Dimensions (Unit: millimeters)

TO-252(D-PAK)



Disclaimers

These materials are intended as a reference to assist our customers in the selection of the Suzhou Good-Ark product best suited to the customer's application; they do not convey any license under any intellectual property rights, or any other rights, belonging to Suzhou Good-Ark Electronics Co., Ltd. or a third party.

Suzhou Good-Ark Electronics Co., Ltd. assumes no responsibility for any damage, or infringement of any third-party's rights, originating in the use of any product data, diagrams, charts, programs, algorithms, or circuit application examples contained in these materials.

All information contained in these materials, including product data, diagrams, charts, programs and algorithms represents information on products at the time of publication of these materials, and are subject to change by Suzhou Good-Ark Electronics Co., Ltd. without notice due to product improvements or other reasons. It is therefore recommended that customers contact Suzhou Good-Ark Electronics Co., Ltd. or an authorized Suzhou Good-Ark Electronics Co., Ltd. for the latest product information before purchasing a product listed herein. The information described here may contain technical inaccuracies or typographical errors. Suzhou Good-Ark Electronics Co., Ltd. assumes no responsibility for any damage, liability, or other loss rising from these inaccuracies or errors. Please also pay attention to information published by Suzhou Good-Ark Electronics Co., Ltd. by various means, including our website home page.

(<http://www.goodark.com>)

When using any or all of the information contained in these materials, including product data, diagrams, charts, programs, and algorithms, please be sure to evaluate all information as a total system before making a final decision on the applicability of the information and products. Suzhou Good-Ark Electronics Co., Ltd. assumes no responsibility for any damage, liability or other loss resulting from the information contained herein.

The prior written approval of Suzhou Good-Ark Electronics Co., Ltd. is necessary to reprint or reproduce in whole or in part these materials.

Please contact Suzhou Good-Ark Electronics Co., Ltd. or an authorized distributor for further details on these materials or the products contained herein.